



# 目 录

一、运输作业组织与管理模块..... 2

二、仓储与配送作业组织与管理模块..... 34

三、国际物流作业组织与管理模块..... 150

四、 快递物流作业组织与管理模块.....	213
-----------------------	-----

湖南商务职业技术学院物流管理专业学生技能考核题库

## 一、运输作业组织与管理模块

○

○

○

--	--	--

○

○

--	--	--	--	--

## ( ) 任务描述

- :
- 
-





<input type="checkbox"/> <input type="checkbox"/>				<input type="checkbox"/> <input type="checkbox"/>				
<input type="checkbox"/> <input type="checkbox"/>								
						<input type="checkbox"/> <input type="checkbox"/> <input type="checkbox"/> <input type="checkbox"/>		





( ) 任务描述:

- 
- 
- 







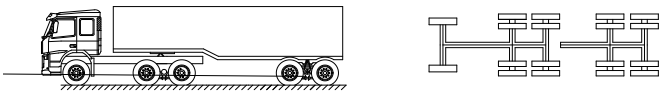
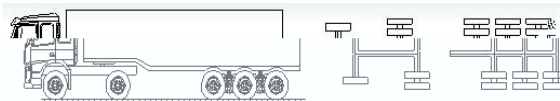

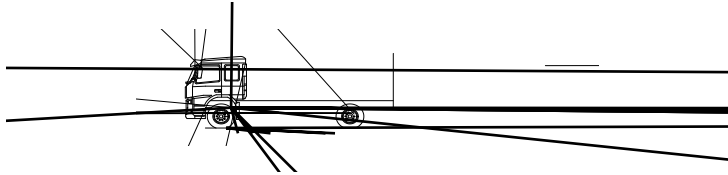
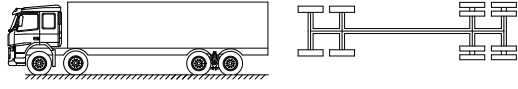
( ) 任务描述:







○

○

○

○

○



( ) 任务描述



**D**

<input type="checkbox"/> <input type="checkbox"/>			<input type="checkbox"/> <input type="checkbox"/>						
<input type="checkbox"/> <input type="checkbox"/>									
						<input type="checkbox"/> <input type="checkbox"/> <input type="checkbox"/> <input type="checkbox"/>			





**2**



**3**

**4**



( ) 任务描述

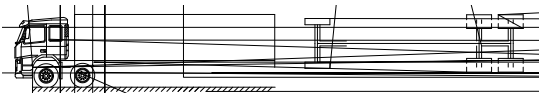
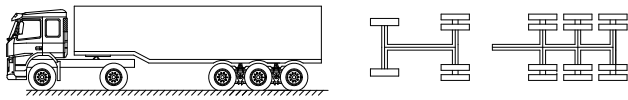
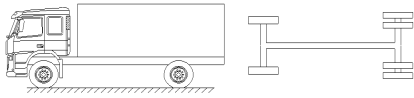







**( ) 任务描述**

- 
- 
- 
- 
- 





( ) 任务描述



○



○

Sailing Schedule from : Shenzhen,Shenzhen,Guangdong,China

To : Los Angeles,Los Angeles,CA,United States

Origin City : Shenzhen,Shenzhen,Guangdong,China

Destination City : Los Angeles,Los Angeles,CA,United States

CY/DOOR

CY/DOOR

序列号	航线	船名	航次	截关时间	装货港	预计离港时间	实际离港时间	卸货港
1	YPSW	YM UNISON	59E	2016-04-22 17:00	Yantian	2016-04-25		Los Angeles
2	SEA	NORTHERN JAVELIN	002E	2016-04-23 12:00	Yantian	2016-04-27		Long Beach
3	AAS2	CMA CGM LIBRA	095TXE	2016-04-25 16:00	Yantian	2016-04-28		Long Beach
4	YPSW	YM UBIQUITY	22E	2016-04-29 17:00	Yantian	2016-05-02		Los Angeles
5	SEA	C SCL PUSAN	117E	2016-04-30 12:00	Yantian	2016-05-04		Long Beach
6	AAS2	CMA CGM COLUMBA	097TXE	2016-05-02 16:00	Yantian	2016-05-05		Long Beach
7	SEA	COSCO NINGBO	069W	2016-05-06 11:00	Yantian	2016-05-08		Long Beach
8	YPSW	YM JIREBY	50E	2016-05-06 17:00	Yantian	2016-05-09		Los Angeles
9	SEA	COSCO EXCELLENCE	027E	2016-05-07 12:00	Yantian	2016-05-11		Long Beach
10	AAS2	CMA CGM CENTAURUS	099TXE	2016-05-09 16:00	Yantian	2016-05-12		Long Beach
11	YPSW	YM MASCULINITY	32E	2016-05-13 17:00	Yantian	2016-05-16		Los Angeles
12	SEA	HONG KONG BRIDGE	039E	2016-05-14 12:00	Yantian	2016-05-18		Long Beach
13	AAS2	CMA CGM THALASSA	101TXE	2016-05-16 16:00	Yantian	2016-05-19		Long Beach



干货箱



	箱体内部尺寸			箱体内容积及载重量		箱门开度尺寸	
	L	W	H	Cu	P	W	H
20'	5898	2352	2393	33.2	21740/28230#	2340	2280
40'	12032	2352	2393	67.7	26630	2340	2280
HC	12032	2352	2698	76.3	26520	2340	2585

冷藏箱



	箱体内部尺寸			箱体内容积及载重量	
	L	W	H	Cu	P
20'	5444	2284	2267	28.5	21135/27160#
40'	11583	2284	2250	58.7	26580

开顶箱

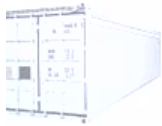

	箱体内部尺寸			箱体内容积及载重量	
	L	W	H	Cu	P
20'	5900	2330	2337	32.6	21740
40'	12025	2330	2337	65.6	26410



( ) 实施条件

( ) 考核时量

( ) 评分细则

1





( ) 任务描述



		<input type="checkbox"/>	<input type="checkbox"/>	<input type="checkbox"/>	<input type="checkbox"/>

<input type="checkbox"/>	<input type="checkbox"/>				
<input type="checkbox"/>	<input type="checkbox"/>				

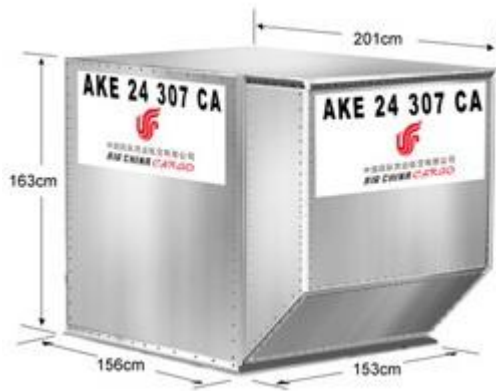

( ) 实施条件

( ) 考核时量

( ) 评分细则



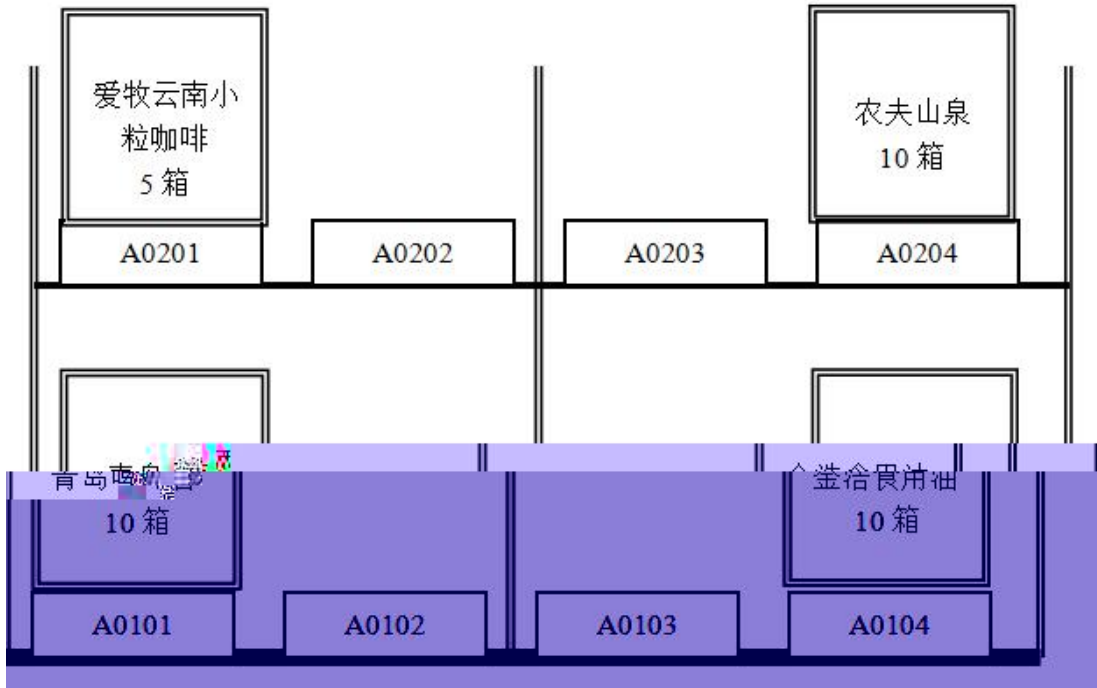

## 产品运输单

---



- 
- 
- 
- 
- 
- 
- 
-





80				





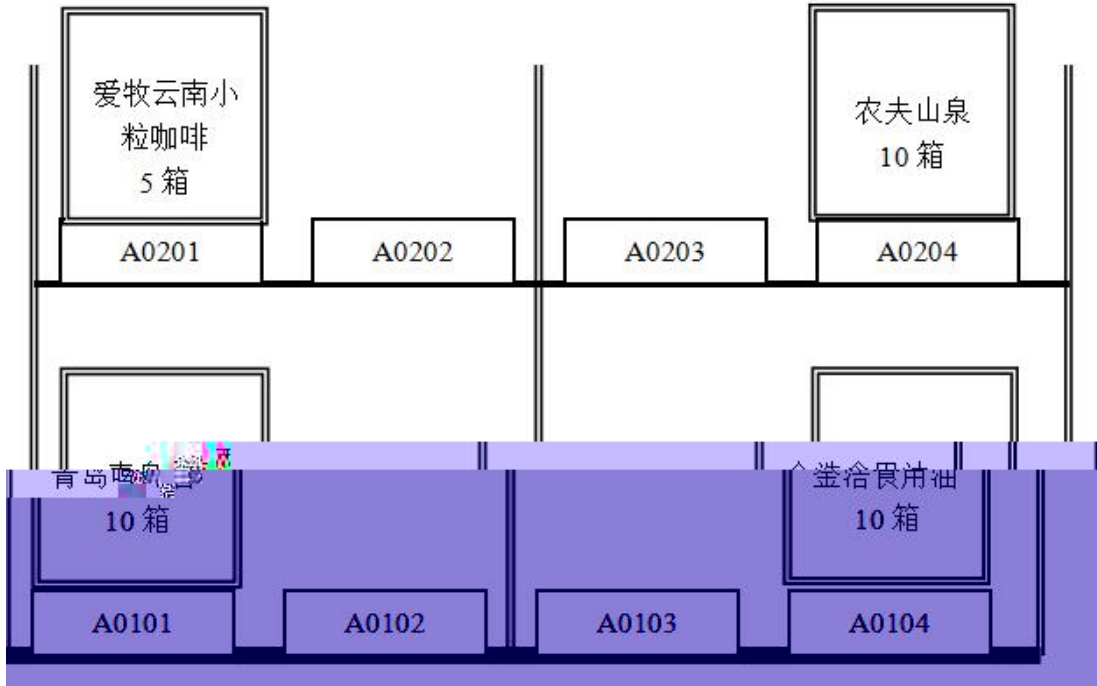



# 产品运输单

---



- 
- 
- 
- 
- 
- 
- 
-











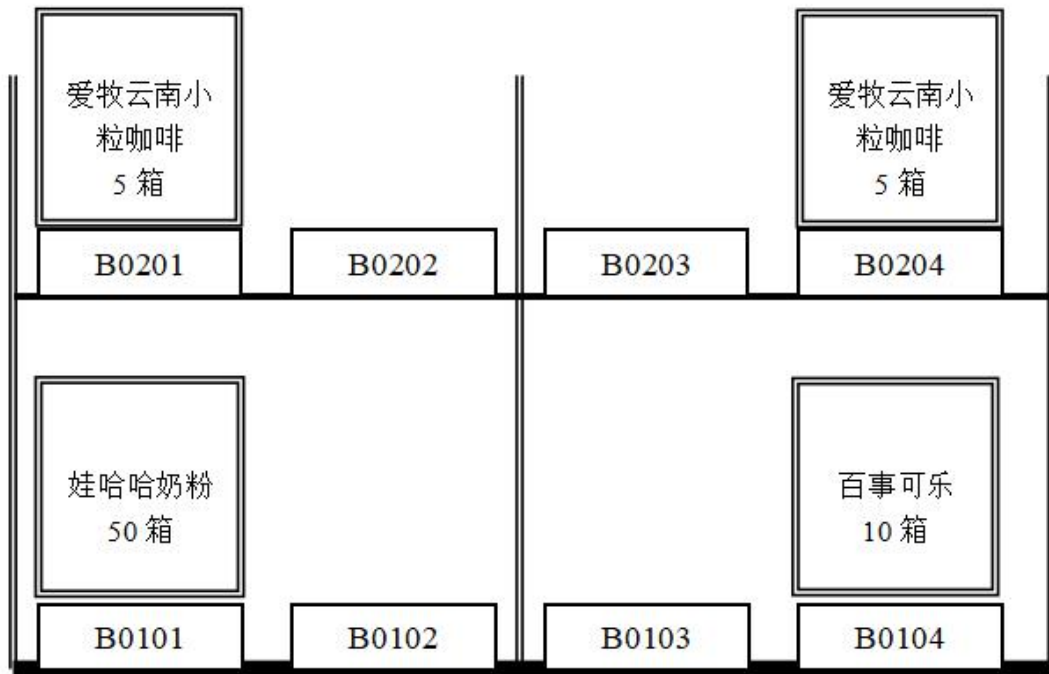
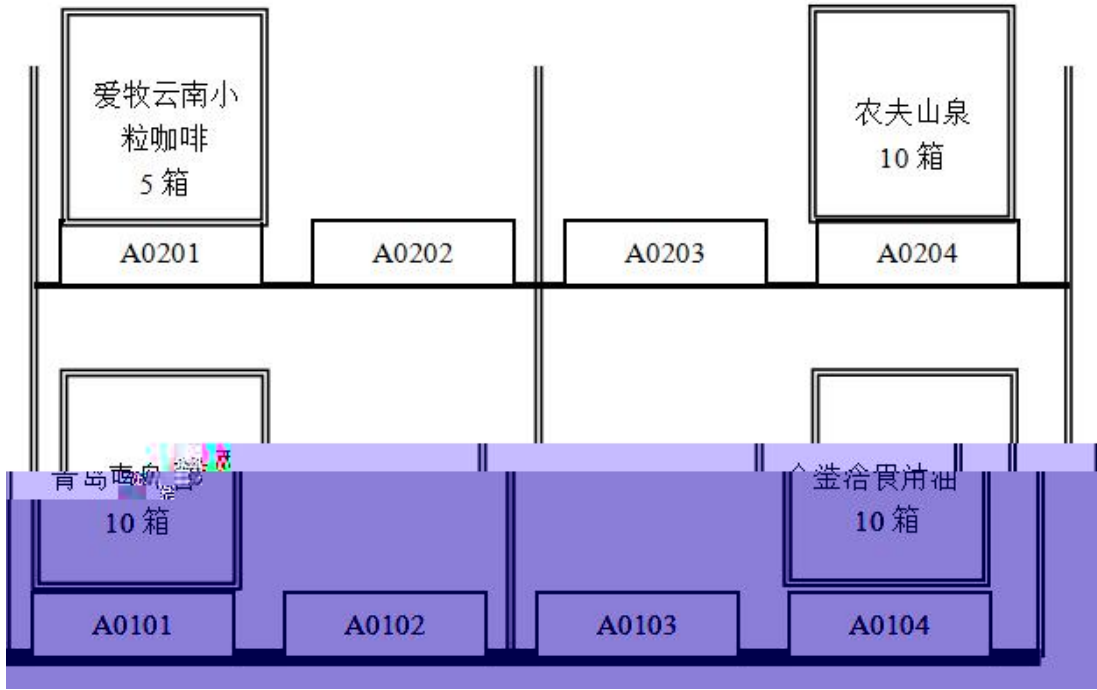



产品运输单



- 
- 
- 
- 
- 
- 
- 
-











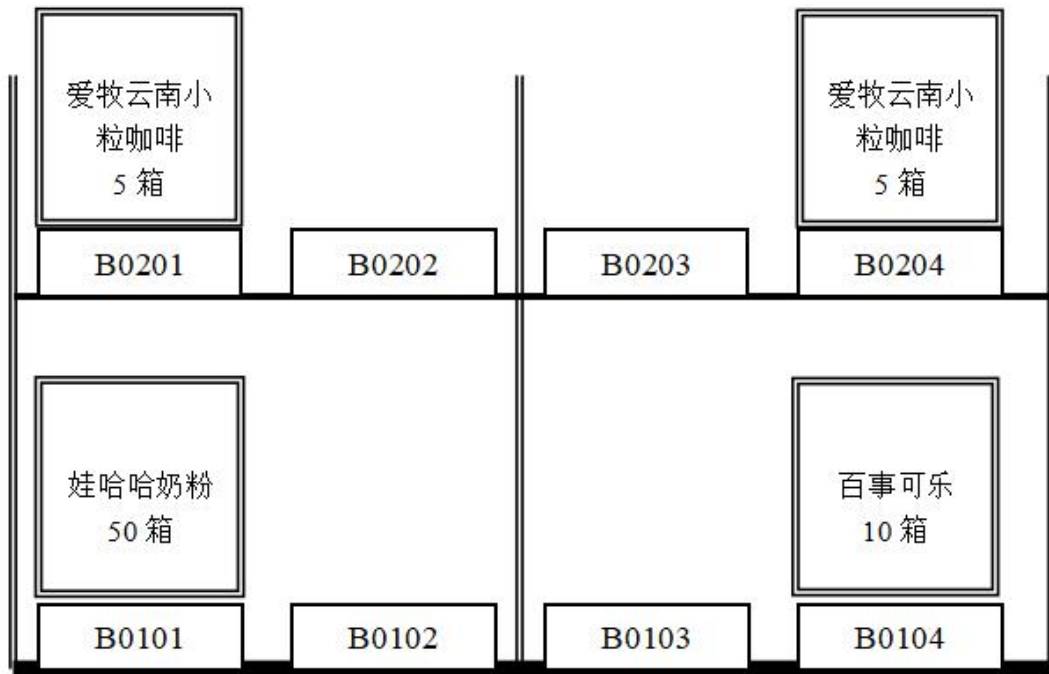
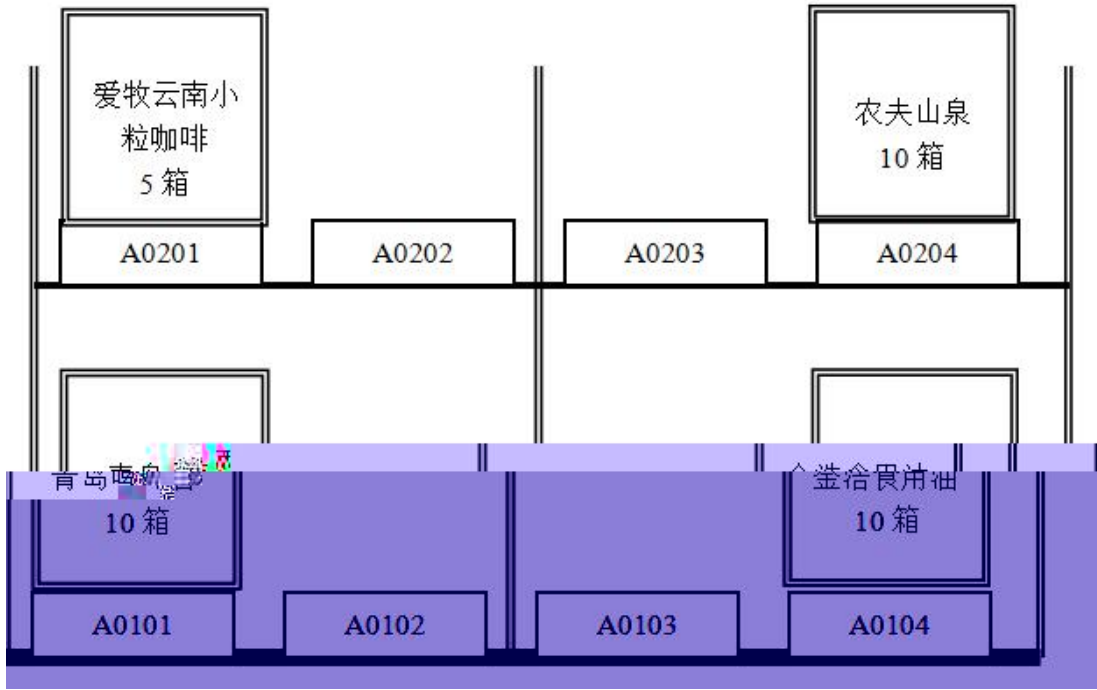

# 产品运输单

---



- 
- 
- 
- 
- 
- 
- 
-





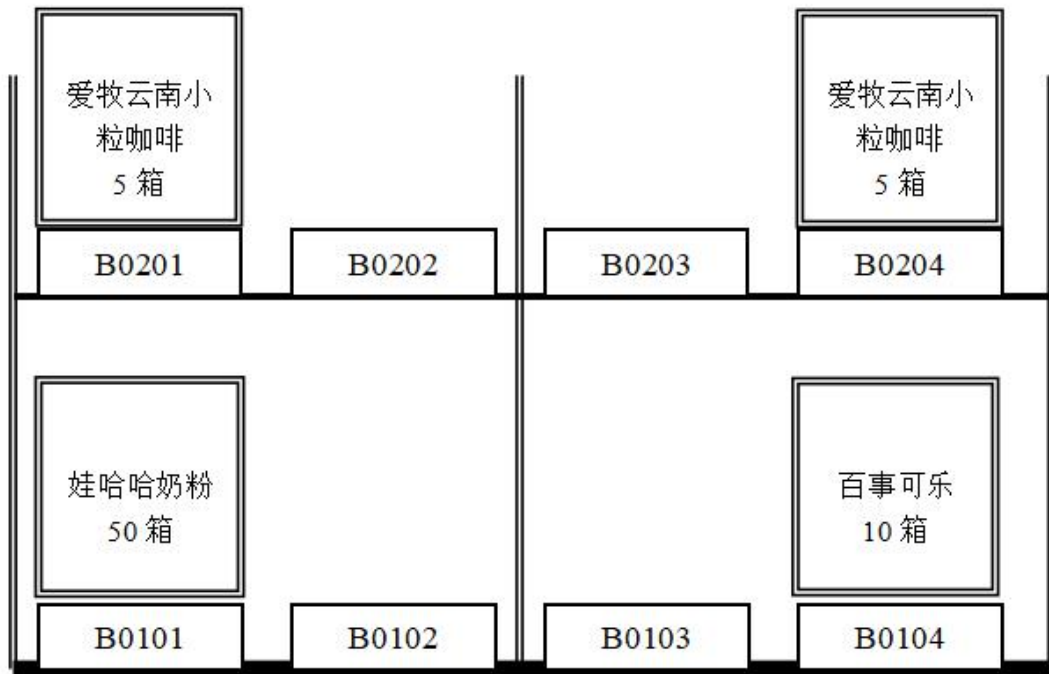
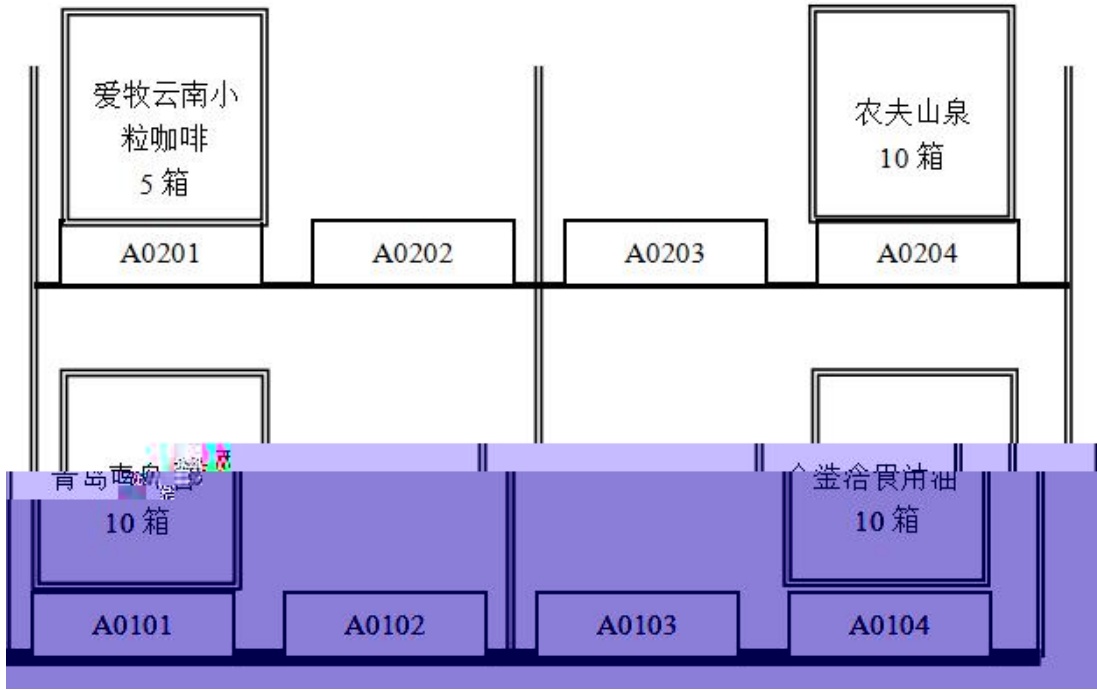

# 产品运输单

---



- 
- 
- 
- 
-







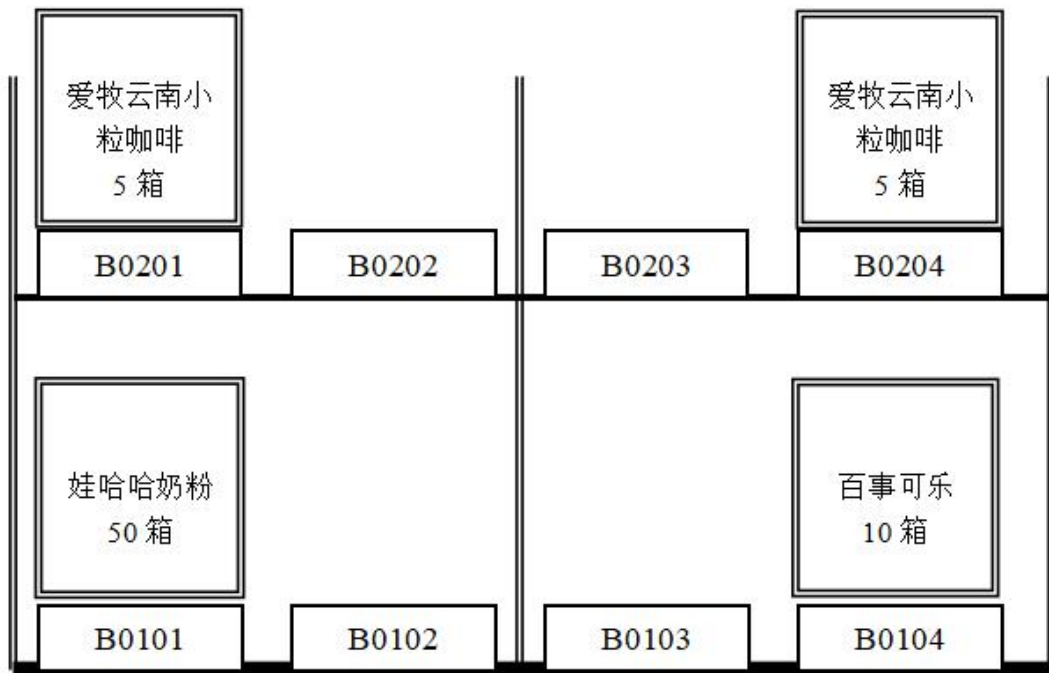
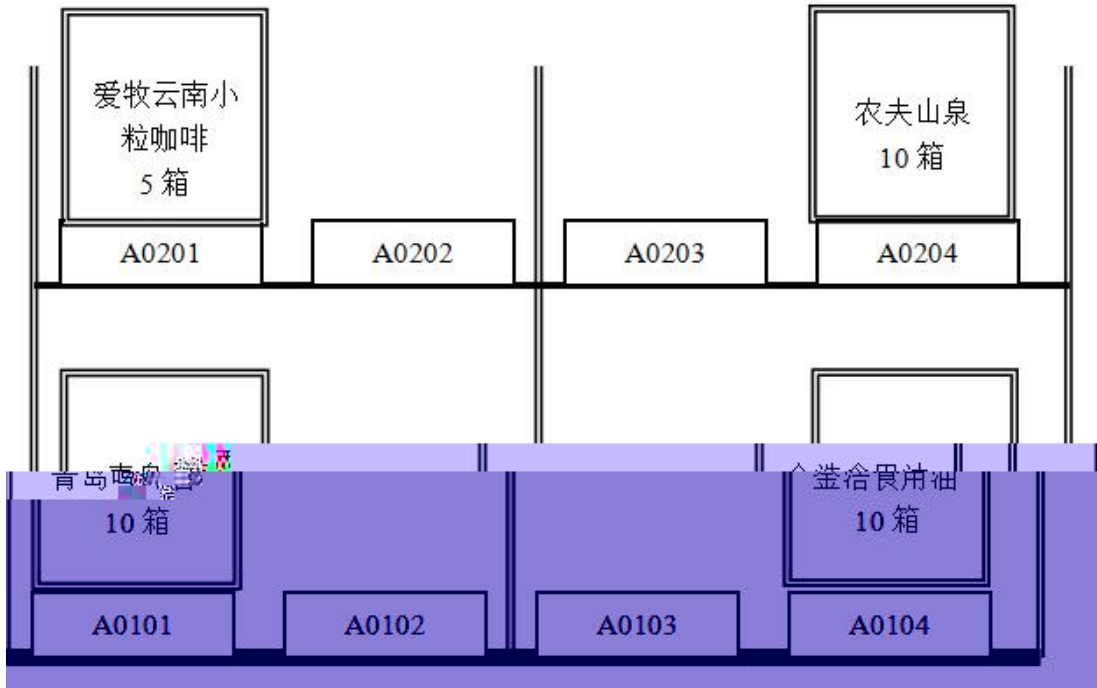

## 产品运输单











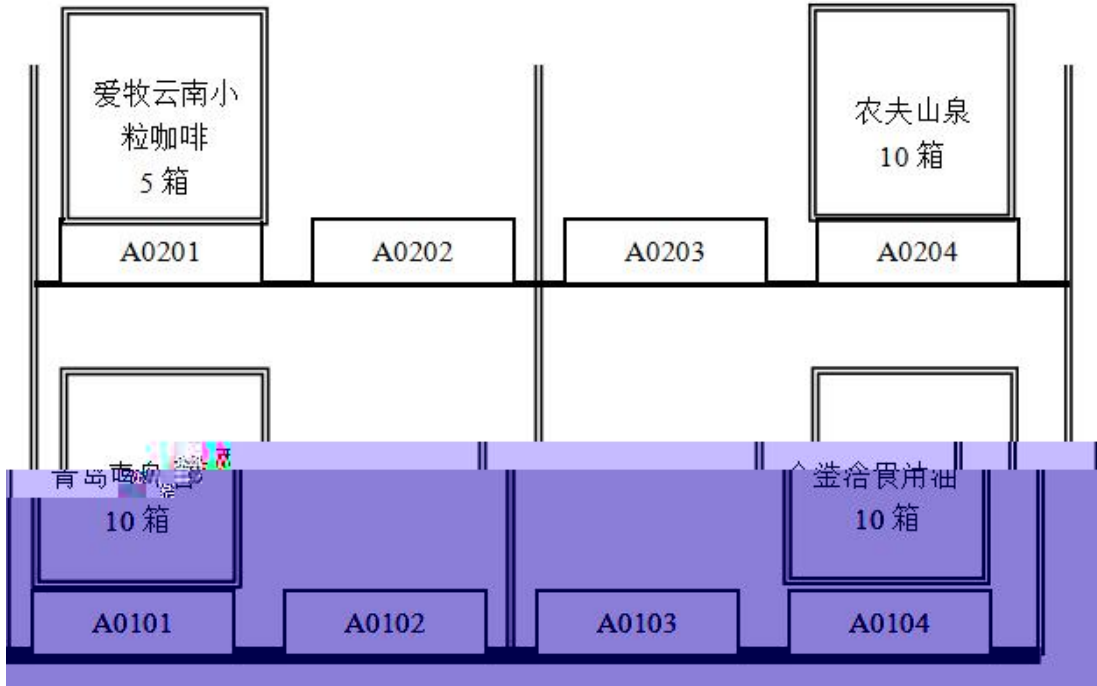

# 产品运输单

---



- 
- 
- 
- 
- 
- 
- 
- 
- 









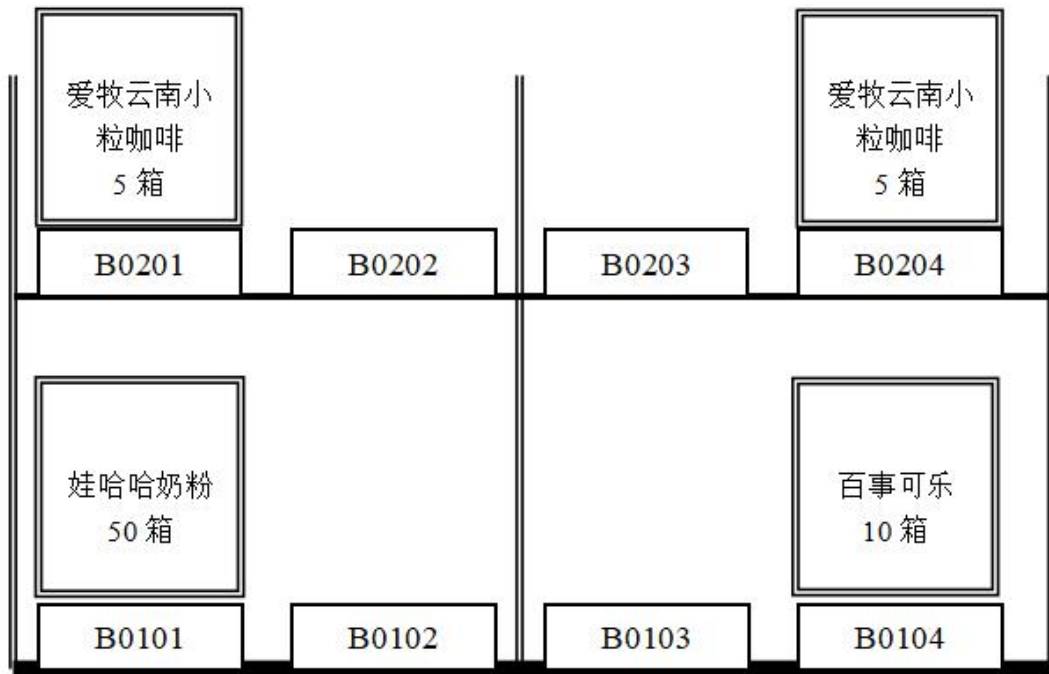
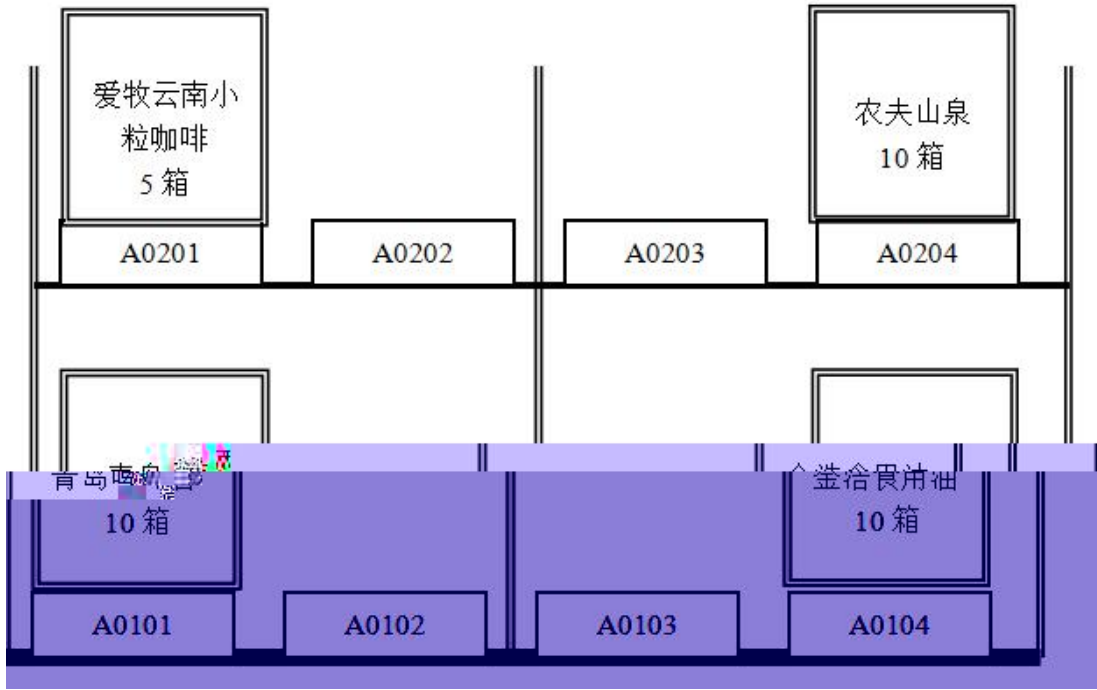

# 产品运输单

---



- 
- 
- 
- 
- 
- 
- 
-









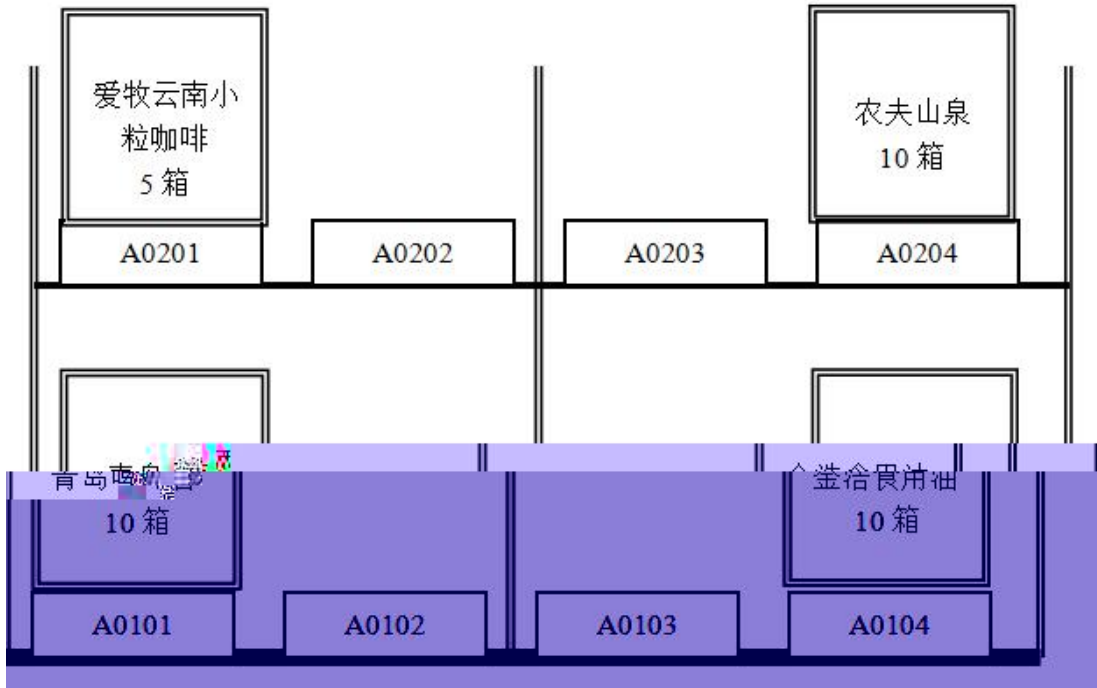

# 产品运输单

---



- 
- 
- 
- 
- 
- 
- 
- 
- 









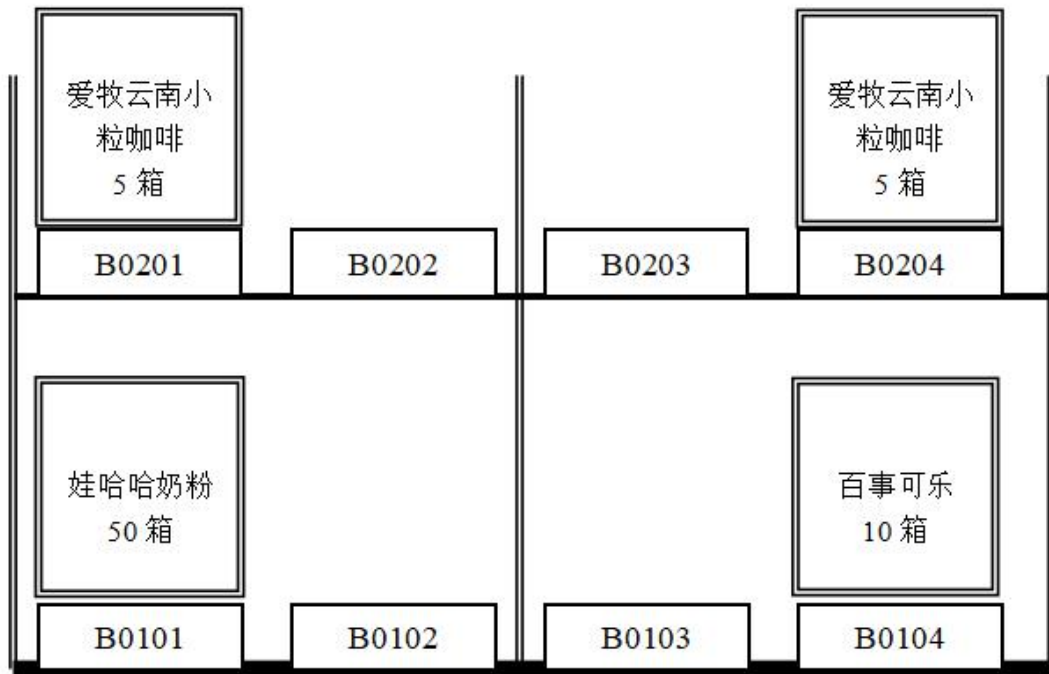
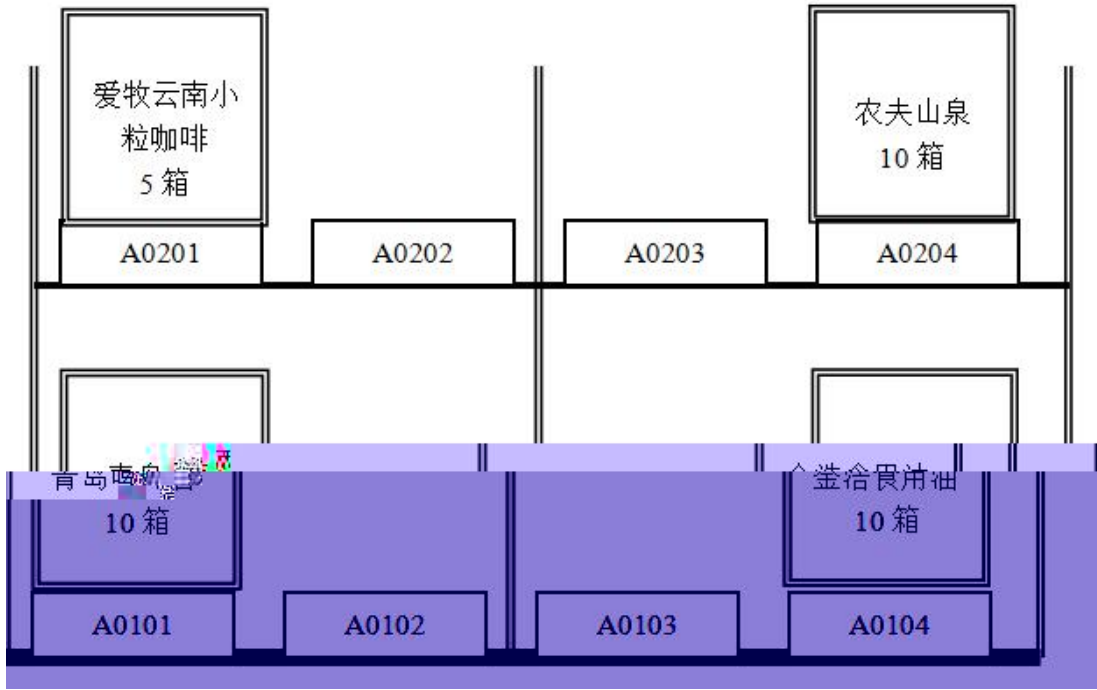

# 产品运输单

---



- 
- 
- 
- 
- 
- 
- 
- 







○

---



---



---

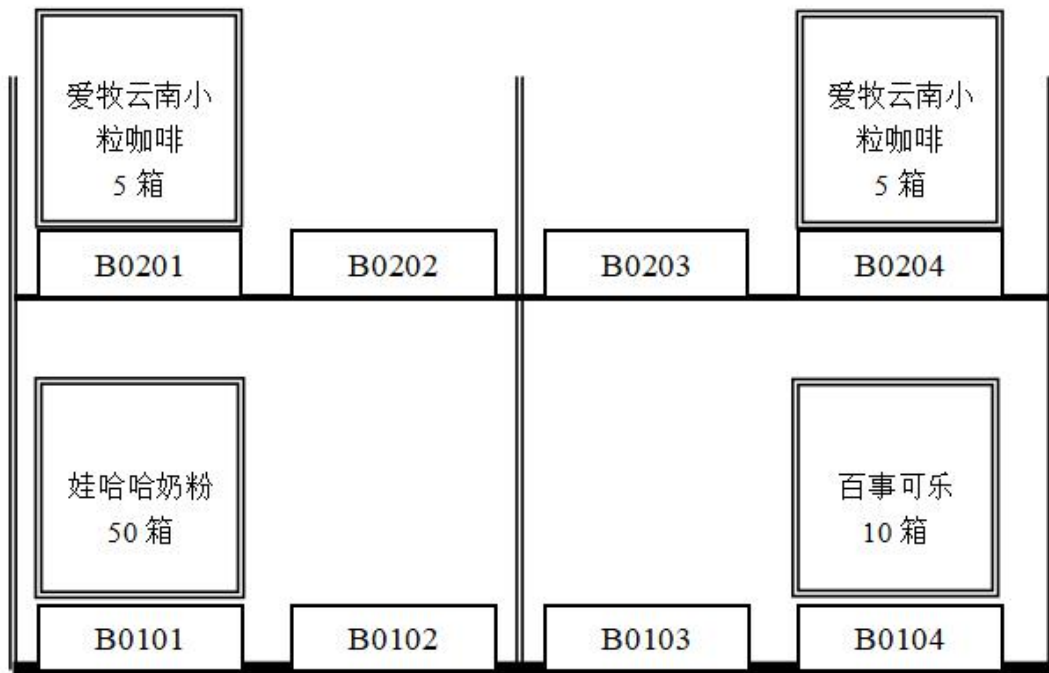
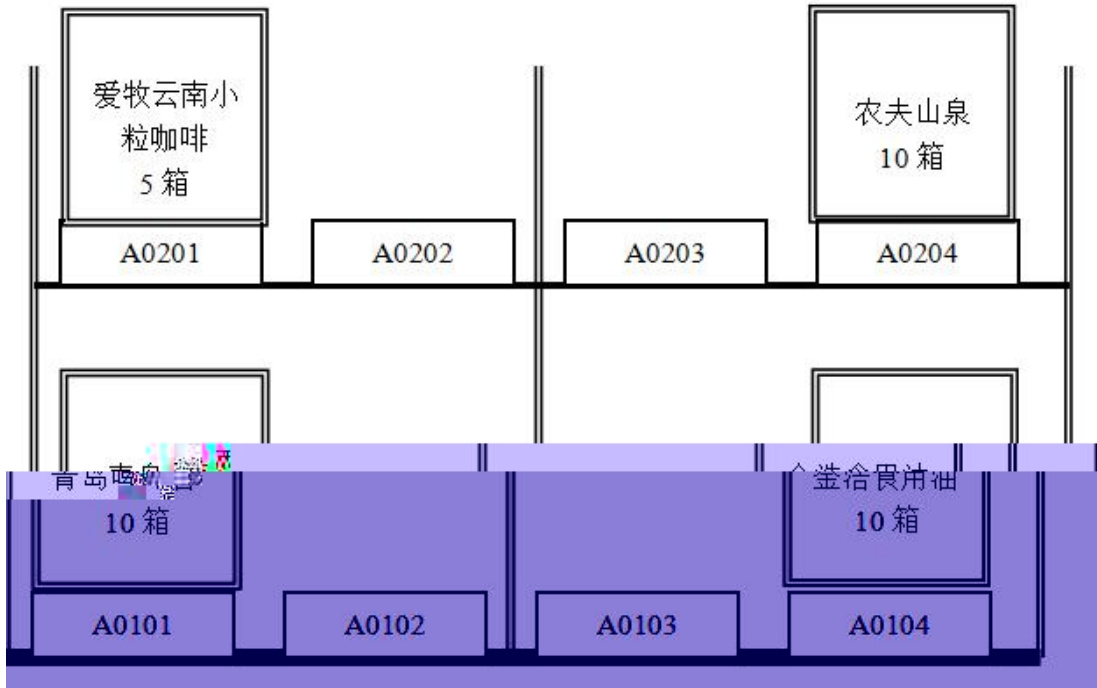







---

--	--	--	--	--	--

---

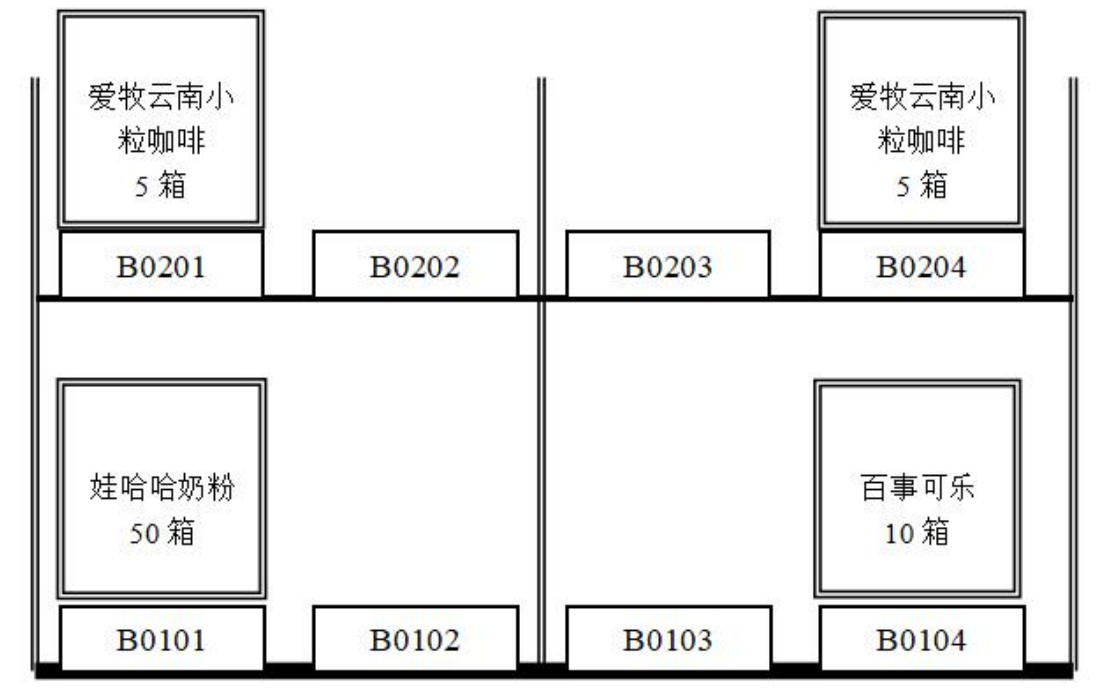
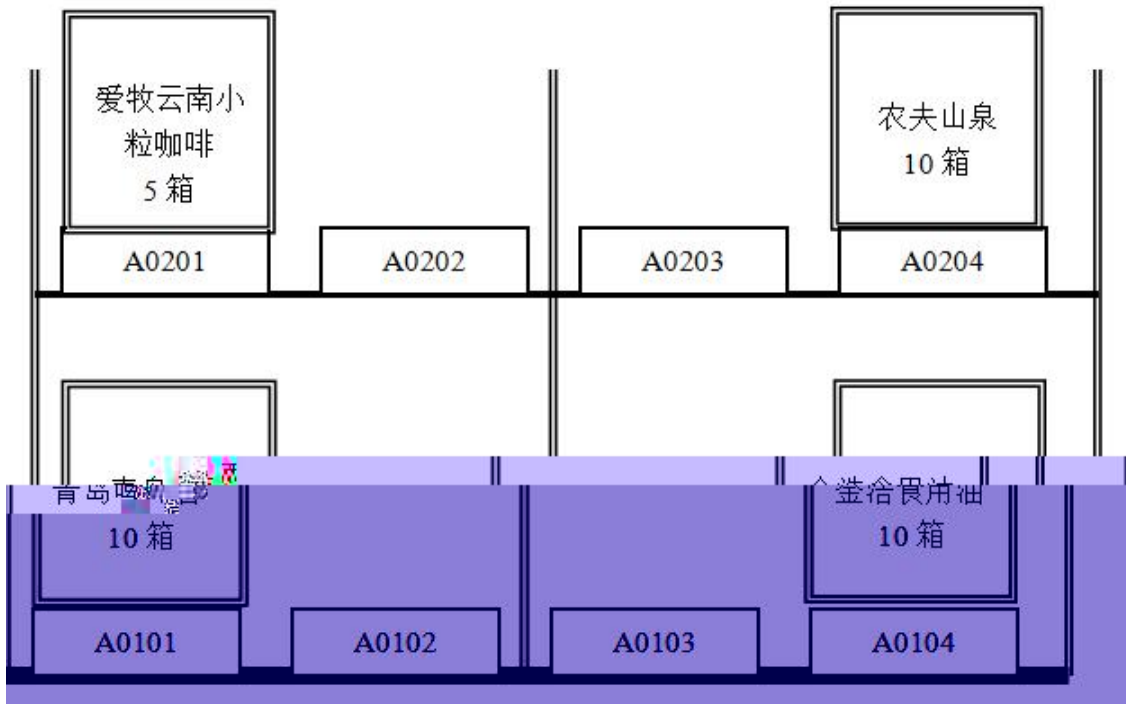

---



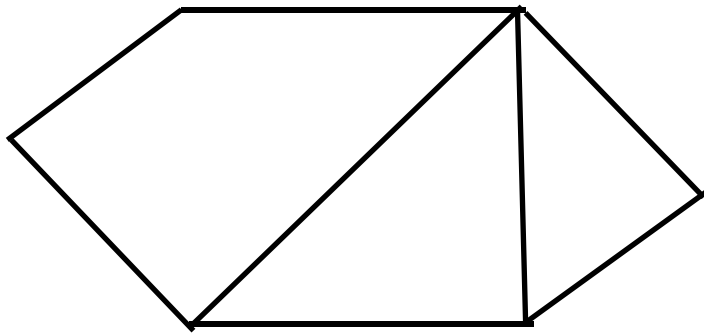







---

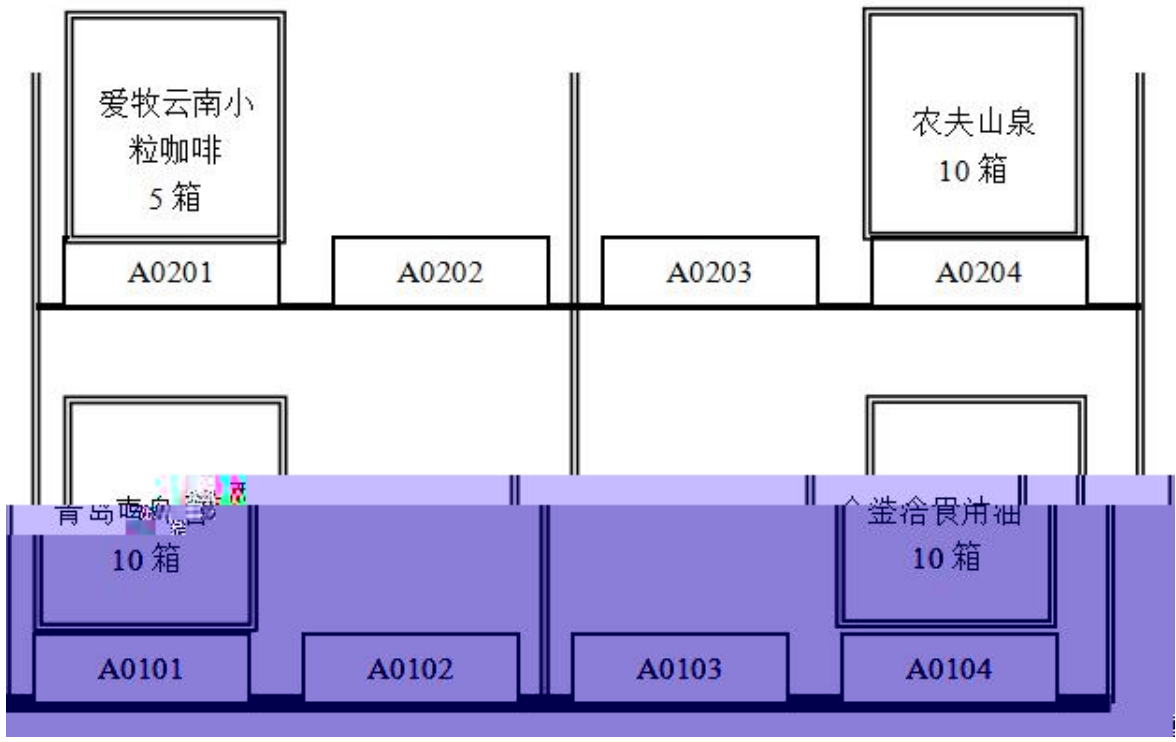

---









**1**

---

		---	---		

---

		---	---		

---

--	--

--- ---



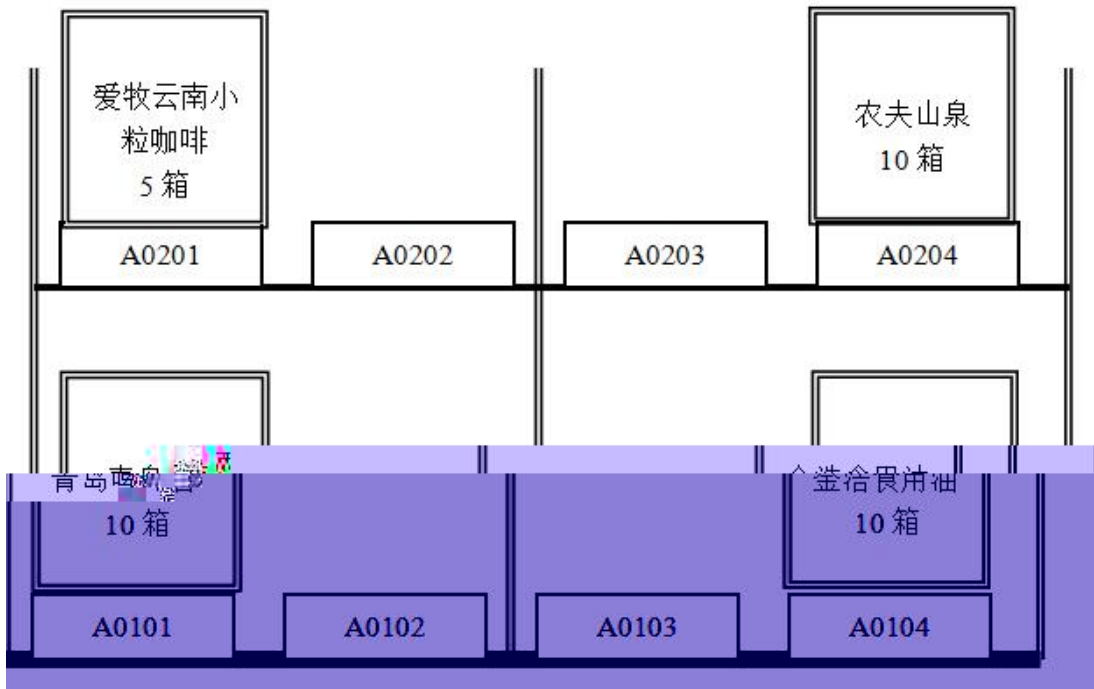





**1**

---

--	--	--	--	--	--

---



---

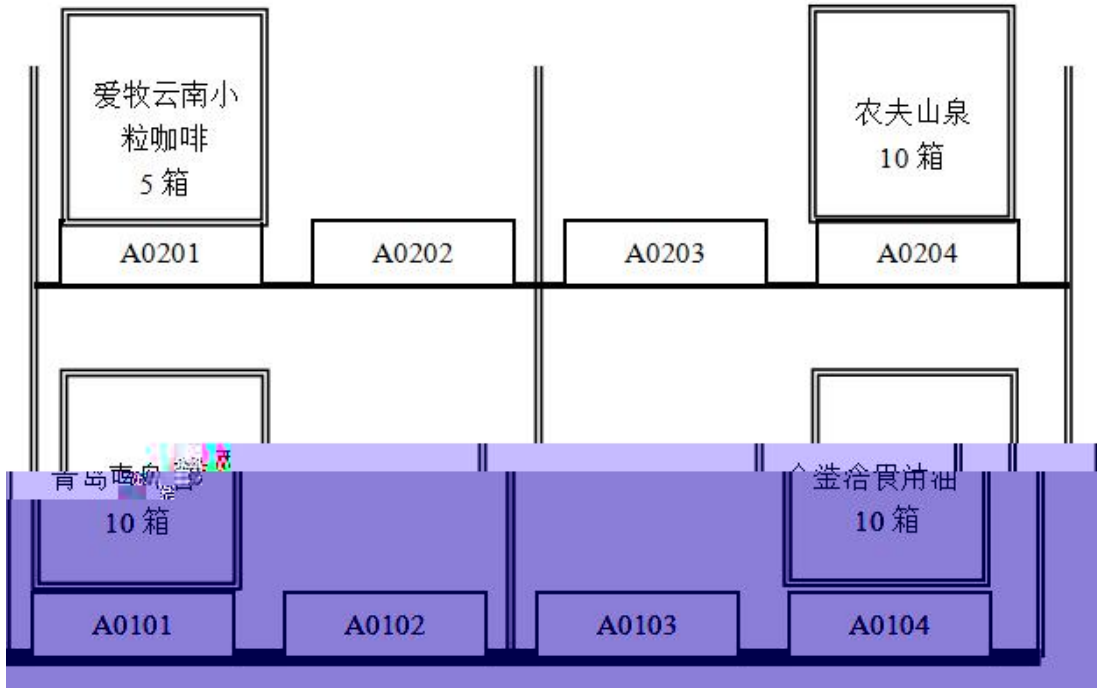











○

○













○

○











○

○













○

○

--	--











○

○







### 三、国际物流作业组织与管理模块



○



---

---

---

---

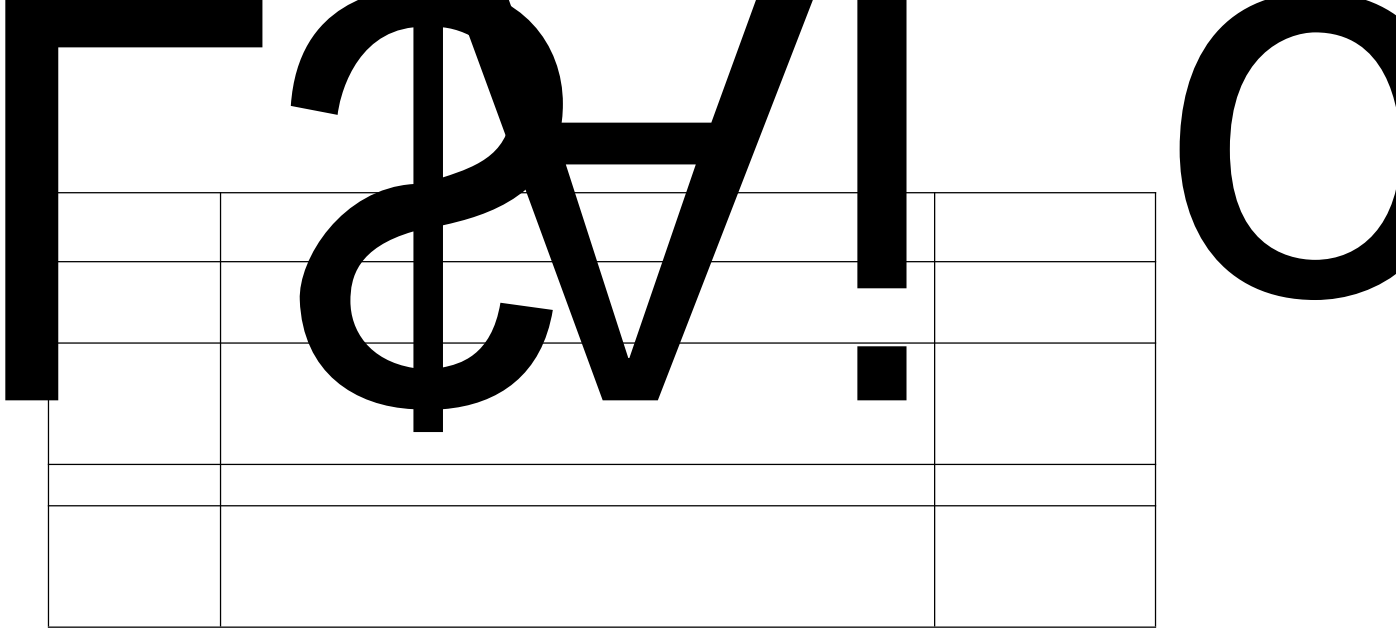

Eÿ

Đ°





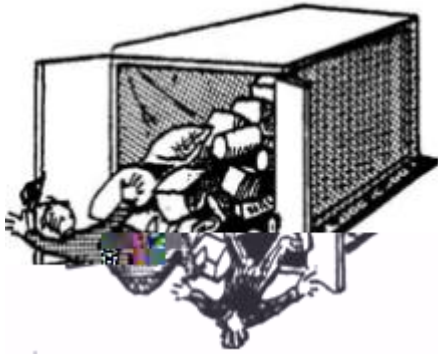
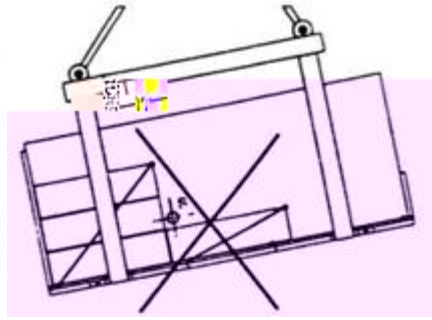



○







○  
○

BEIJING	CN		BJ\$
Y. RENMINBI	CNY		KGS
		100	100.00
		200	200.00
		300	300.00
		400	400.00
		500	500.00
		600	600.00
		700	700.00
		800	800.00
		900	900.00
		1000	1000.00

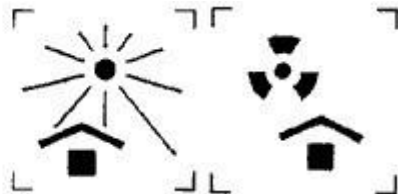



○





○

○







---

---

---

---

---

---

---

---

集装箱设备交接单  
EQUIPMENT INTERCHANGE RECEIPT

OUT 出场

No.

用箱人/运箱人 (CNTR. USER/HAULIER)		提箱地点 (PLACE OF DELIVERY)
发往地点 (DELIVERED TO)	返回/收箱地点 (PLACE OF RETURN)	













--	--	--	--	--	--

















--	--	--



--	--	--	--	--	--





--	--	--	--	--	--

--	--	--	--	--	--	--	--

○











8E8E\_P4y









○

--	--	--











--	--	--	--	--	--

○

○

○



○







#### 四、 快递物流作业组织与管理模块























--	--	--	--	--	--

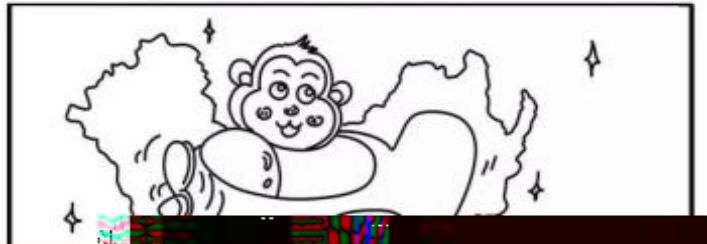
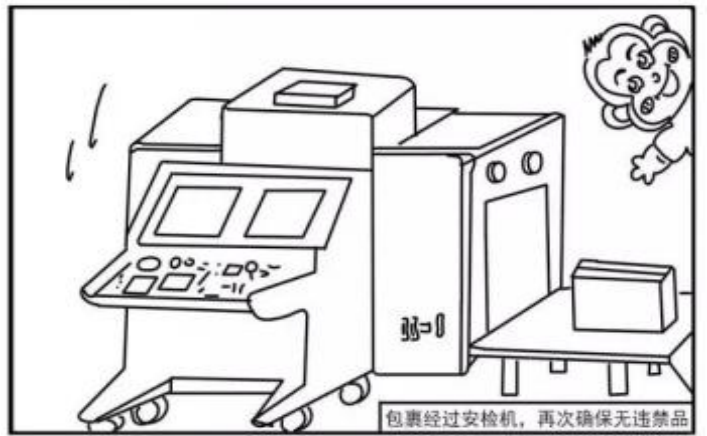



--	--	--	--	--	--



L'œ( œ\* 5Š

Ê













---





--	--	--	--	--	--



[想知道:中国成都理工大学校园快递具体在哪? 百度知道](#)

3个回答 - 提问时间: 2014年02月10日

最佳答案=韵达在银杏后面。宝盒、圆通、顺丰在电影院后面。中通、申通在图书馆下面。常用的是这几个。

[zhidao.baidu.com/link?... 2014-02-15](#) - 百度快照 - 80%好评



















--	--	--	--



















--	--	--	--















































































<hr/>
-------

